

MONITORACK

SOMMAIRE

- 1. PRÉSENTATION DE L'ENTREPRISE**
- 2. PRÉSENTATION DU PROJET**
- 3. INFRASTRUCTURE PROPOSÉE**
- 4. PARTIE PERSONNELLE**
- 5. BILAN**

PRÉSENTATION DE L'ENTREPRISE

CI SOLUTIONS

UNE ENTREPRISE SITUÉE À LONS (64).

TÉLÉPHONIE IP, SÉCURITÉ, RÉSEAU

LE DÉPLOIEMENT DE SERVEURS DANS DES BAIES.

HÉBERGE PLUSIEURS GAMMES DE SERVEURS

BAIES AVEC ONDULEURS



PRESENTATION D'UN ONDULEUR

L'APC SMART UPS 3000VA



AUTONOMIE:

SERVEUR PÉDAGOGIQUE: 230W

SERVEUR ANTI-VIRUS: 350W

AUTONOMIE = 33 MINUTES

GRAPHIQUE D'AUTONOMIE:



AUTONOMIE ONDULEUR

GRAPHIQUE D'AUTONOMIE:

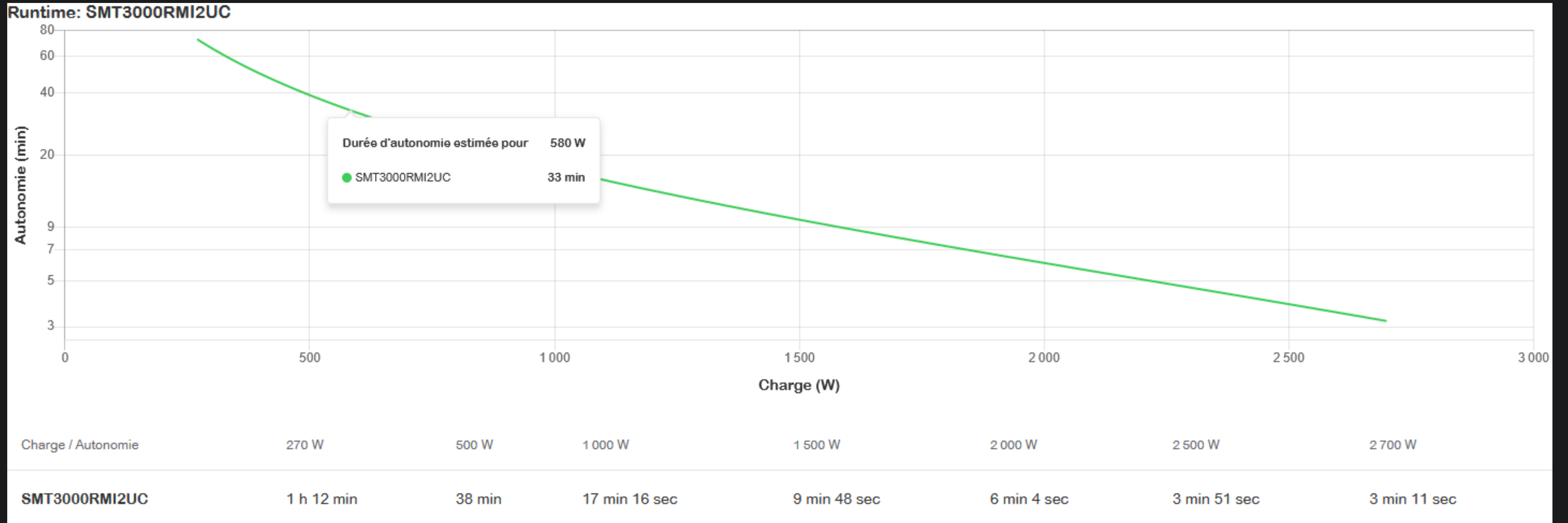

COMMENT FONCTIONNENT UN ONDULEUR

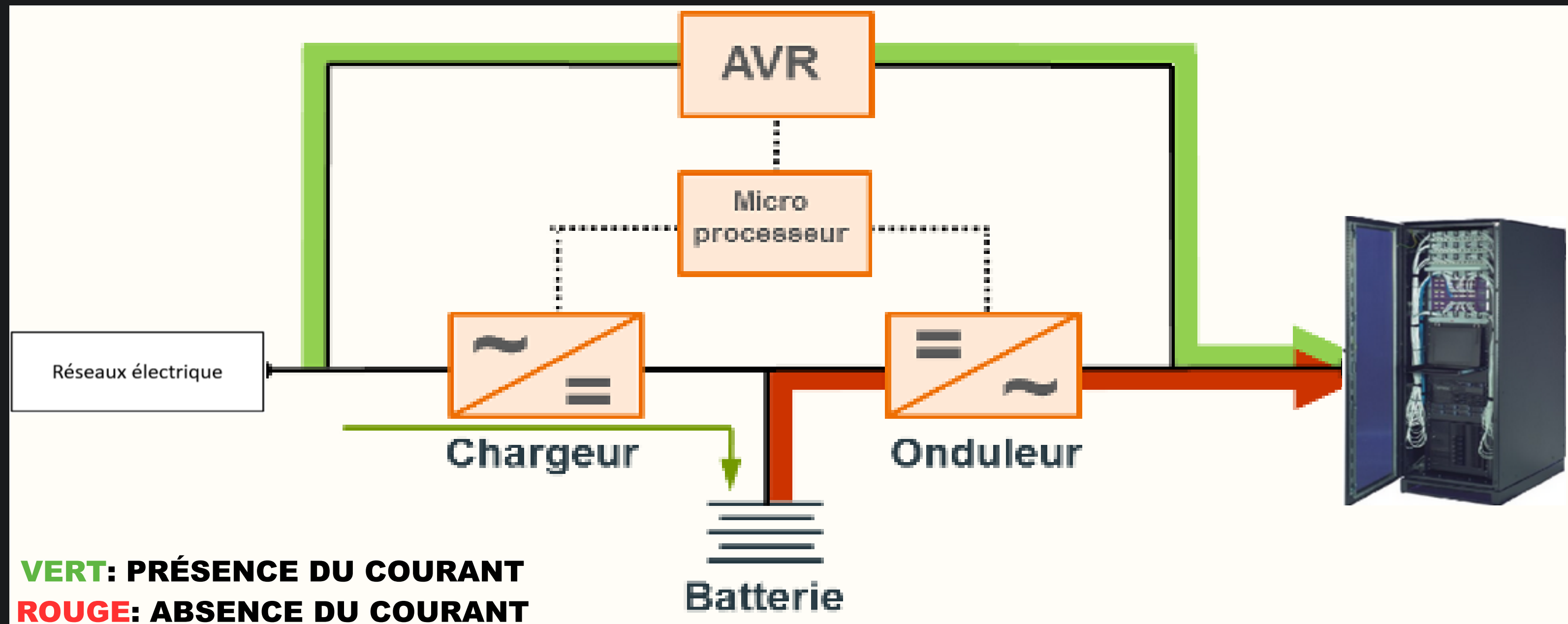

TYPES D'ONDULEURS

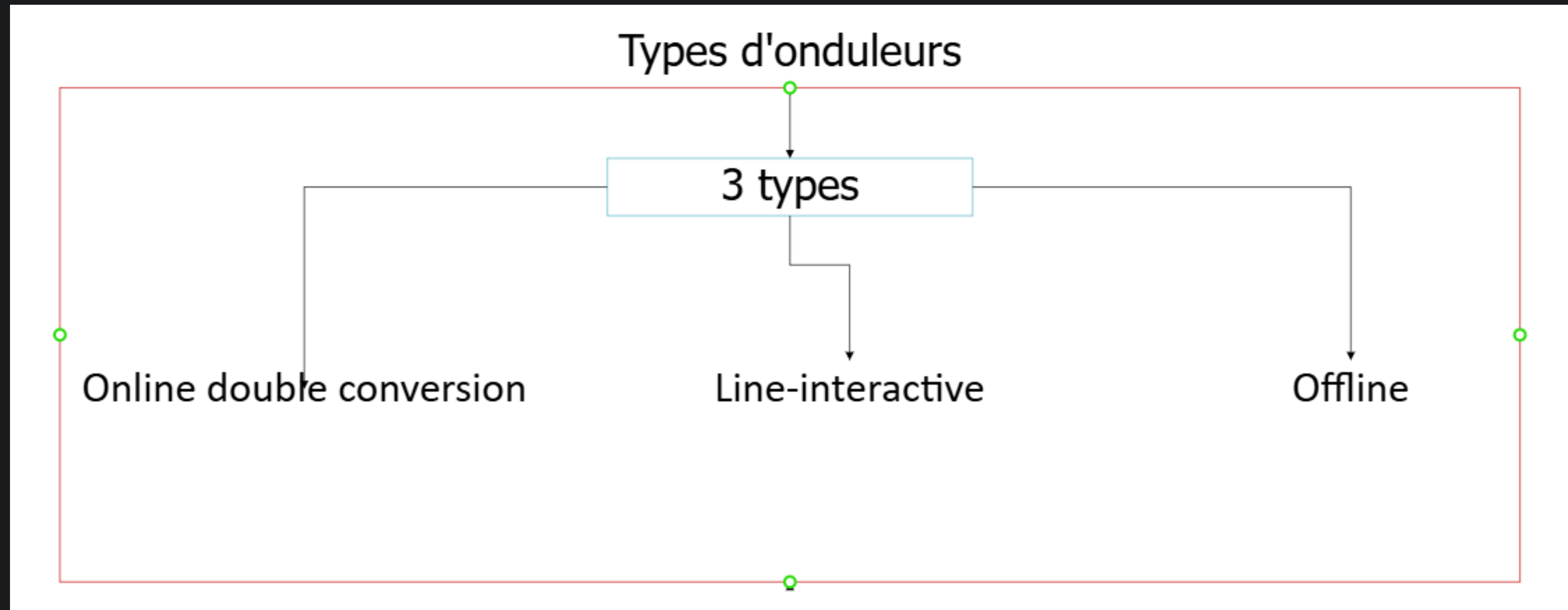

LES GRANDEURS TRANSMISES

- **Température (24°C)**
- **Taux d'humidité (50%)**
- **Niveau batterie (100%)**
- **Autonomie de la batterie (time)**
- **État porte (fermée)**
- **État onduleur (baie sur secteur)**

INFRASTRUCTURE PROPOSÉE

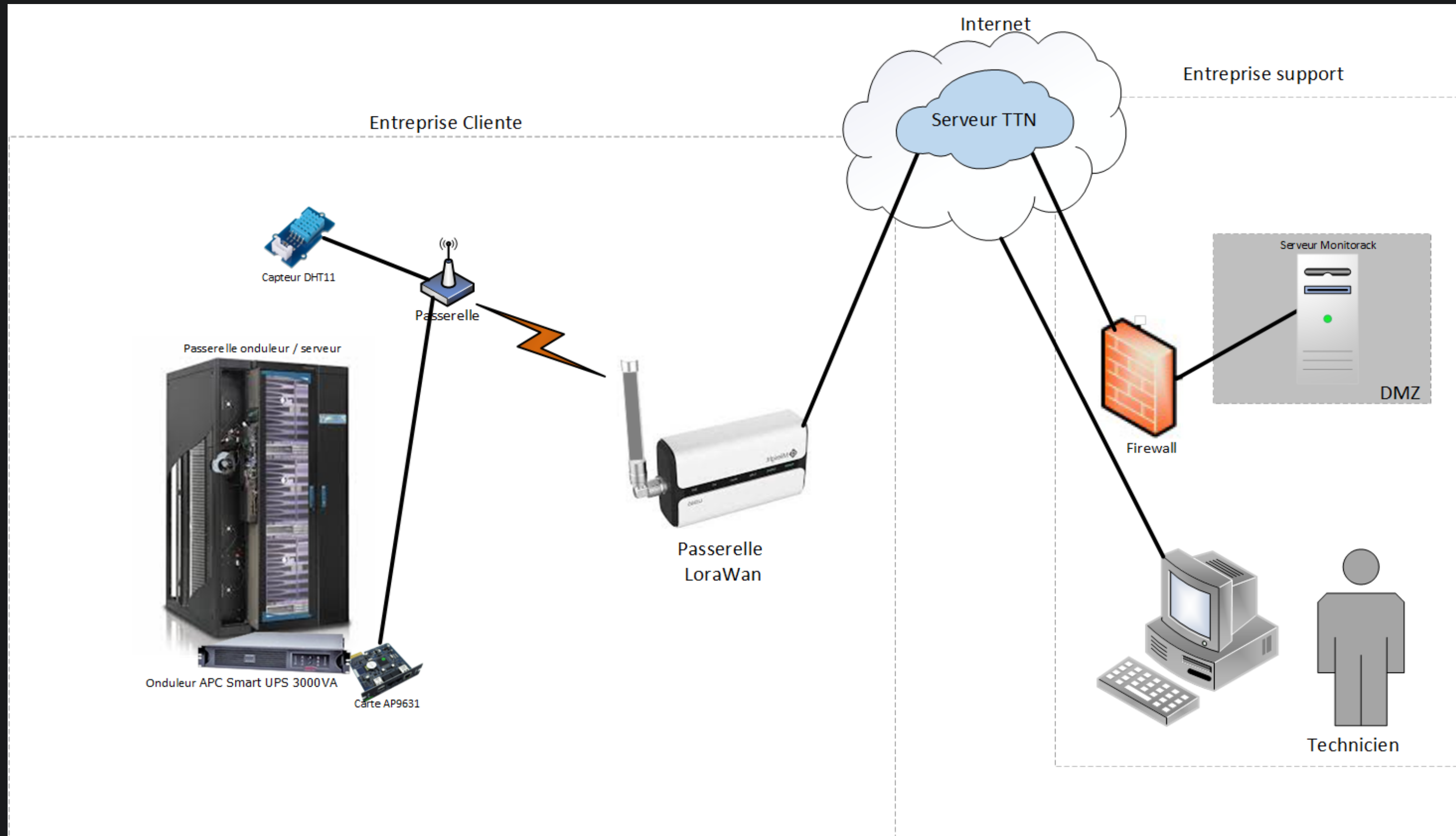

TECHNOLOGIES EMPLOYÉES

RPI avec C++ / QT

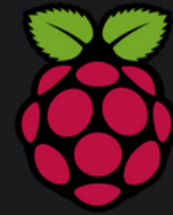

#Passerelle LoRaWan



MariaDB (Base de données)



Symfony



#Bootstrap



RÉPARTITION DU TRAVAIL

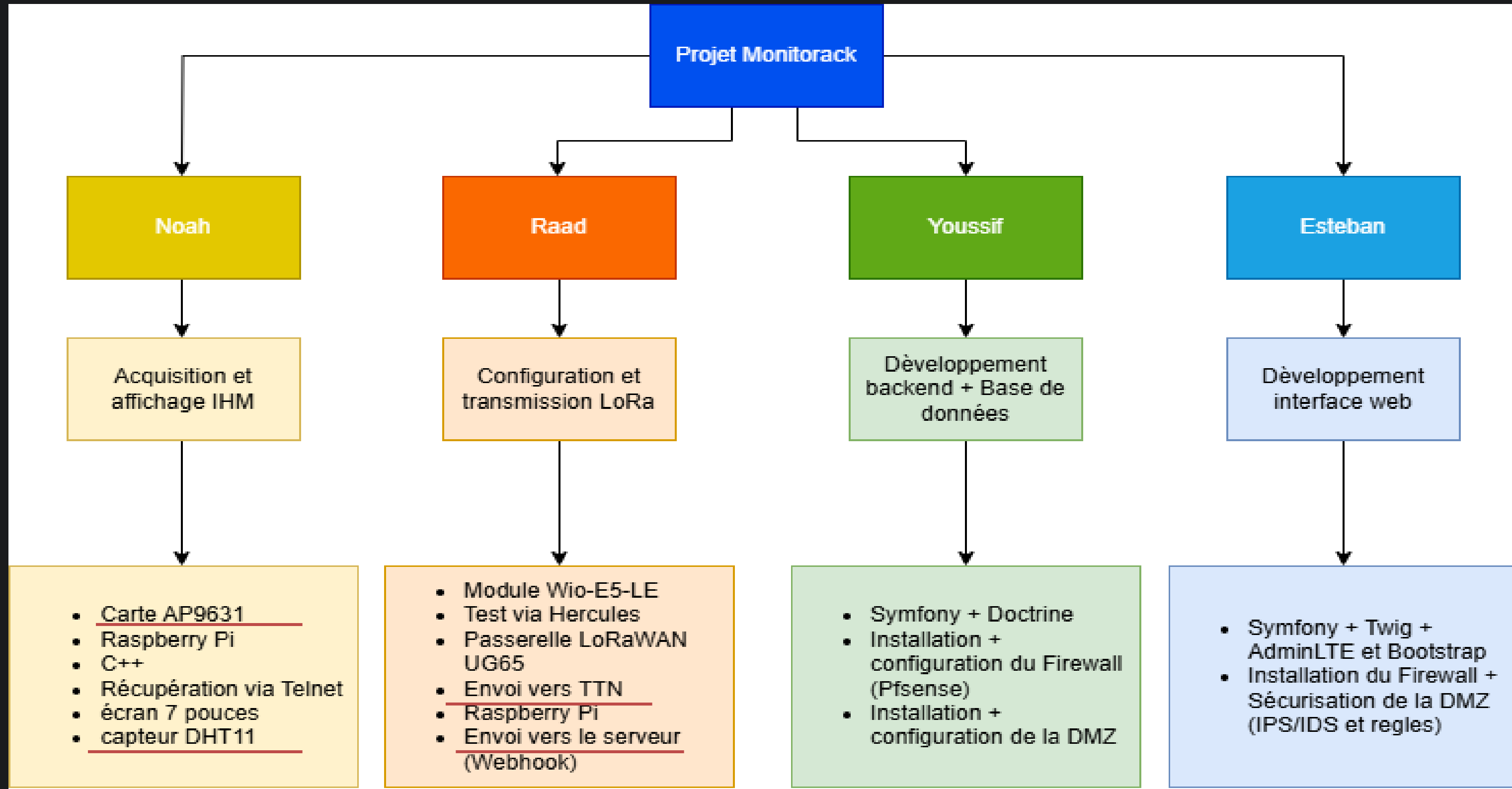

PARTIE PERSONNELLE : OBJECTIF

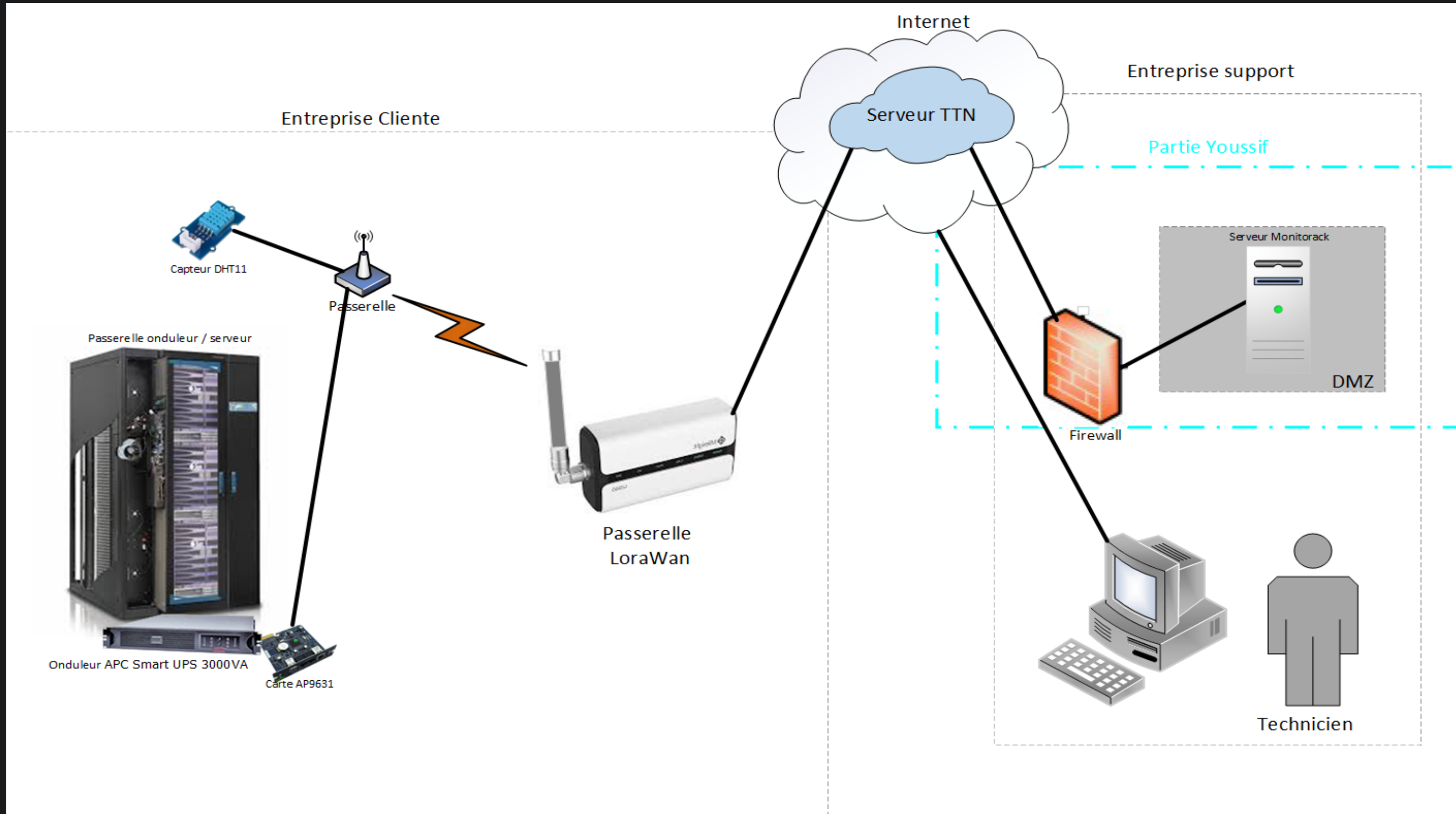

INTERFACES

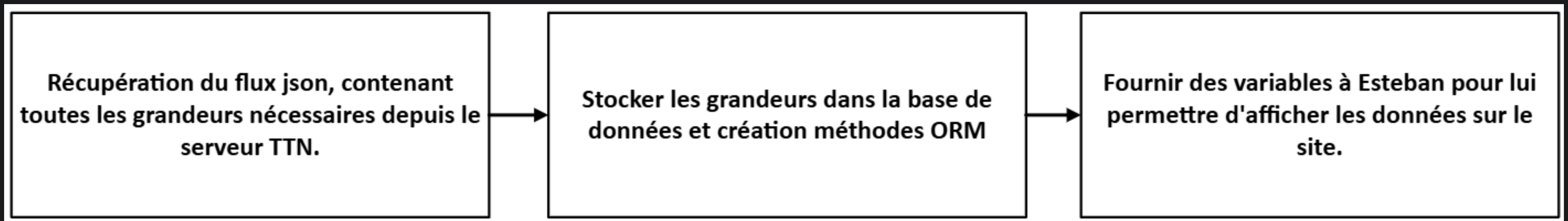

SYMFONY

- Framework PHP
- Création des site web complexes, robustes, fiables, maintenables et performants.
- Architecture MVC

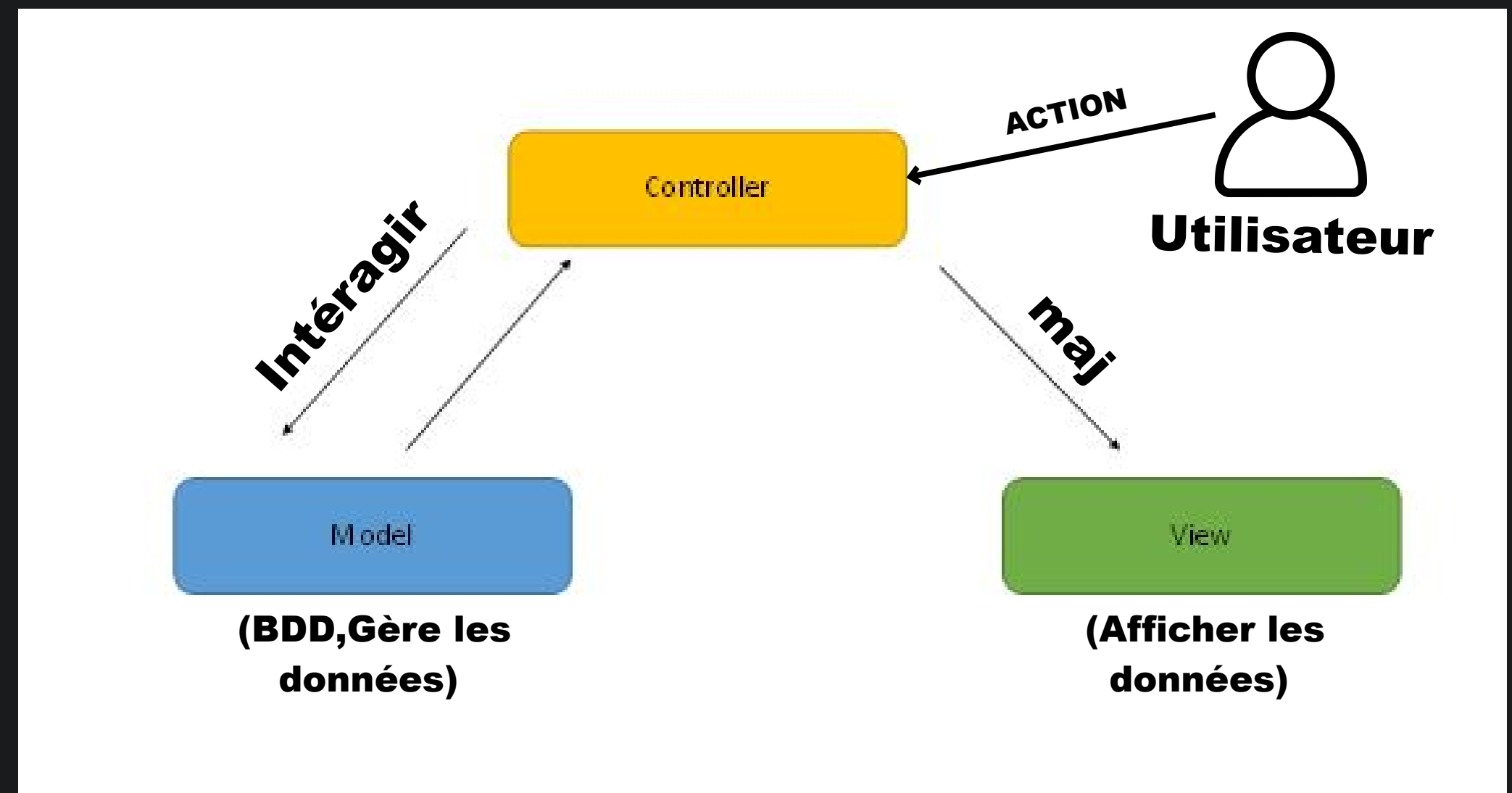

UNE ROUTE SYMFONY

MonitorackController:

```
#[Route('/baie/{id}', name: 'baie', methods: ['GET'])]
public function baie(int $id, BaiesRepository $unebaie ): Response
{
    $grandeurs = $unebaie->findOneBy(['id' => $id]);
    return $this->render('monitorack/uneBaie.html.twig', ['baie' => $grandeurs]);
}
```

Résultat:

10.10.1.192:8000/baie/1



La baie 1

ID	id de l'entreprises	Nom de la baie	localisation de la baie	ip de la baie
1	1	monitorack	10 rue de la république, 64000 Pau	10.10.1.192

DOCTRINE

- **ORM (Object-Relational Mapper)**
- **librairie PHP**
- **faciliter la manipulation de ses bases de données**

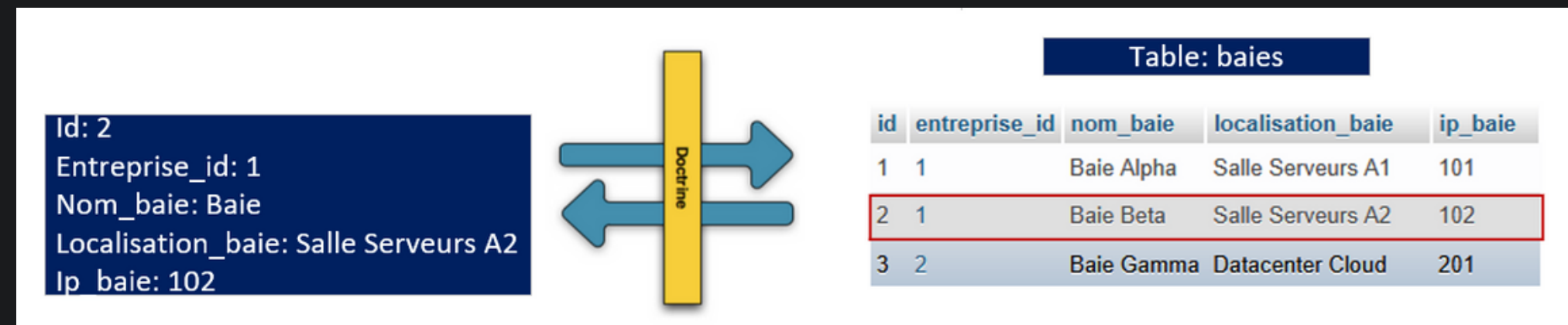

```
php bin/console make:migration  
php bin/console doctrine:migrations:migrate
```

ENTITY

GRANDEURS.PHP

La classe ----->

Attribut ----->

Méthodes ----->

```
class Grandeurs
{
    #[ORM\Id]
    #[ORM\GeneratedValue]
    #[ORM\Column]
    private ?int $id = null;

    #[ORM\Column]
    private ?float $temp = null;

    public function getTemp(): ?float
    {
        return $this->temp;
    }

    public function setTemp(float $temp): static
    {
        $this->temp = $temp;

        return $this;
    }
}
```

CONCEPTION BASE DE DONNÉES

v Monitorack entreprises	
🔑	entreprise_id : int(11)
📄	nom_entreprise : varchar(45)
📄	adresse : varchar(45)
📄	coordonnees : varchar(45)

v Monitorack baies	
🔑	id : int(11)
#	entreprise_id : int(11)
📄	nom_baie : varchar(100)
📄	localisation_baie : varchar(45)
📄	ip_baie : varchar(15)

v Monitorack grandeurs	
🔑	id : int(11)
#	temp : double
#	niv_bat : double
#	hum : smallint(6)
📄	autonomie_bat : time
#	etat_porte : tinyint(1)
#	etat_ond : tinyint(1)
#	Baies_id : int(11)

v Monitorack doctrine_migration_versions	
🔑	version : varchar(191)
📄	executed_at : datetime
#	execution_time : int(11)

REPOSITORY

GRANDEURSREPOSITORY:

```
class GrandeursRepository extends ServiceEntityRepository
{
    public function __construct(ManagerRegistry $registry)
    {
        parent::__construct($registry, Grandeurs::class);
    }

    /**
     * Affichage d'une baie
     */
    public function findGrandeursByBaieId(int $id): ?array
    {
        $qb = $this->createQueryBuilder('g')
            ->select(
                'b.id AS baie_id',
                'b.nomBaie',
                'b.localisationBaie',
                'b.ipBaie',
                'e.entreprise_id AS entreprise_id',
                'g.id AS grandeur_id',
                'g.temp',
                'g.tempPiece',
                'g.nivBat',
                'g.hum',
                'g.autonomieBat',
                'g.etatPorte',
                'g.etatOnd'
            )
            ->leftJoin('g.baies', 'b')
            ->leftJoin('b.entreprise', 'e')
            ->where('b.id = :id')
            ->setParameter('id', $id)
            ->orderBy('g.id', 'DESC')
            ->setMaxResults(1);

        return $qb->getQuery()->getOneOrNullResult();
    }
}
```

ON CRÉE LA MÉTHODE ----->

ON SÉLECTIONNE DES CHAMPS----->











ON FAIT DES JOINTURES----->

ON FILTRE PAR L'ID----->

ON TRIE ET LIMITE----->

RÉSULTAT FINAL

```
{ "baie_id": 1, "nomBaie": "Baie Alpha", "localisationBaie": "Salle Serveurs A1", "ipBaie": "101", "entreprise_id": 1, "grandeur_id": 761, "temp": 23, "tempPiece": 30, "nivBat": 100, "hum": 39, "autonomieBat": { "date": "04:30:00.00", "timezone_type": 3, "timezone": "UTC" }, "etatPorte": false, "etatOnd": false }
```

Baie Alpha		
 ID 1	 Id de l'entreprise 1	 Nom de la baie Baie Alpha
 Localisation de la baie Salle Serveurs A1	 IP de la baie 101	 Température de la batterie 23°C
 Niveau de batterie 100%	 Humidité 39%	 Autonomie de la batterie 04:30
 Température de la baie 30°C	 État de la porte Fermé	

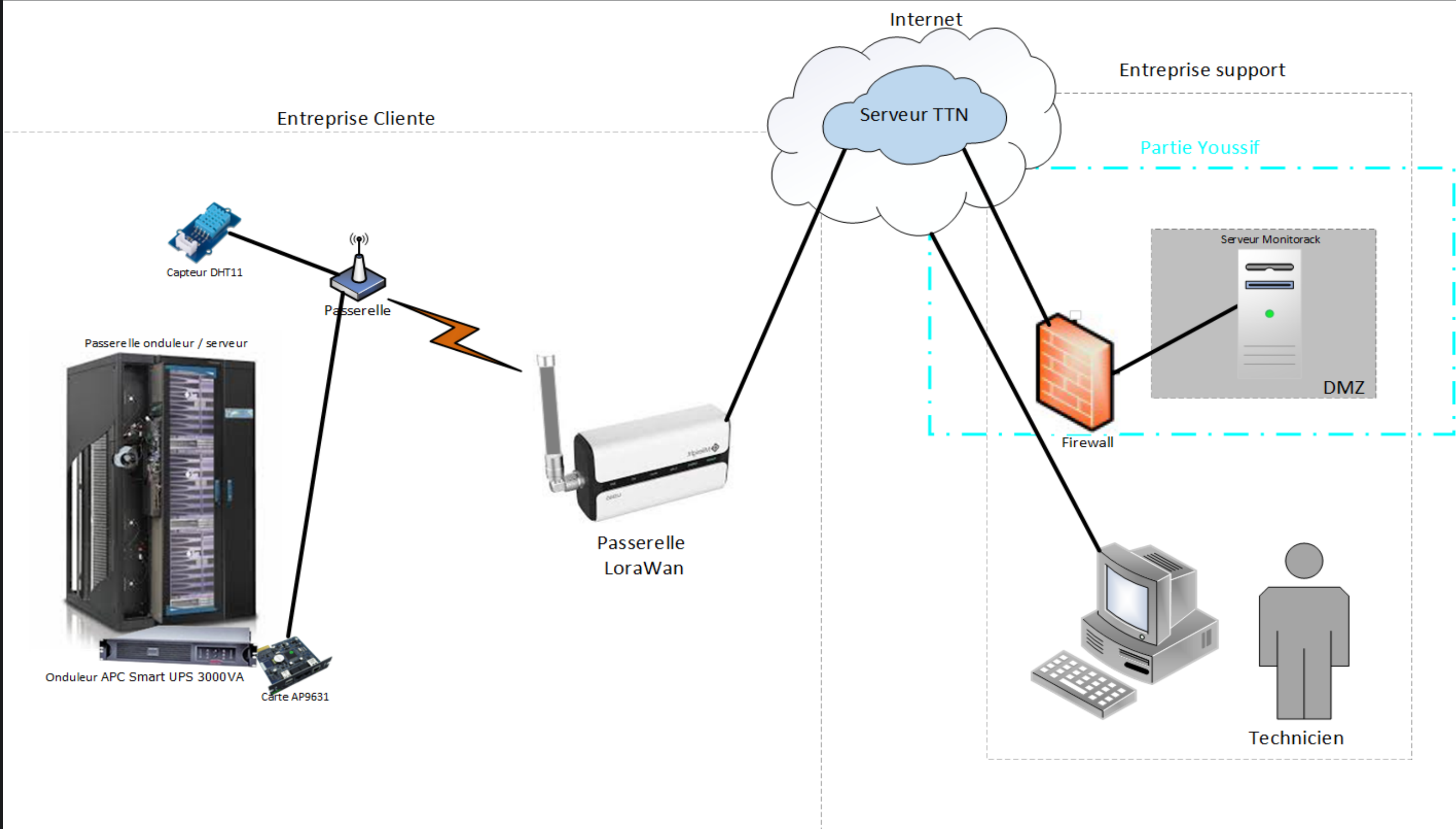

PFSENSE + DMZ





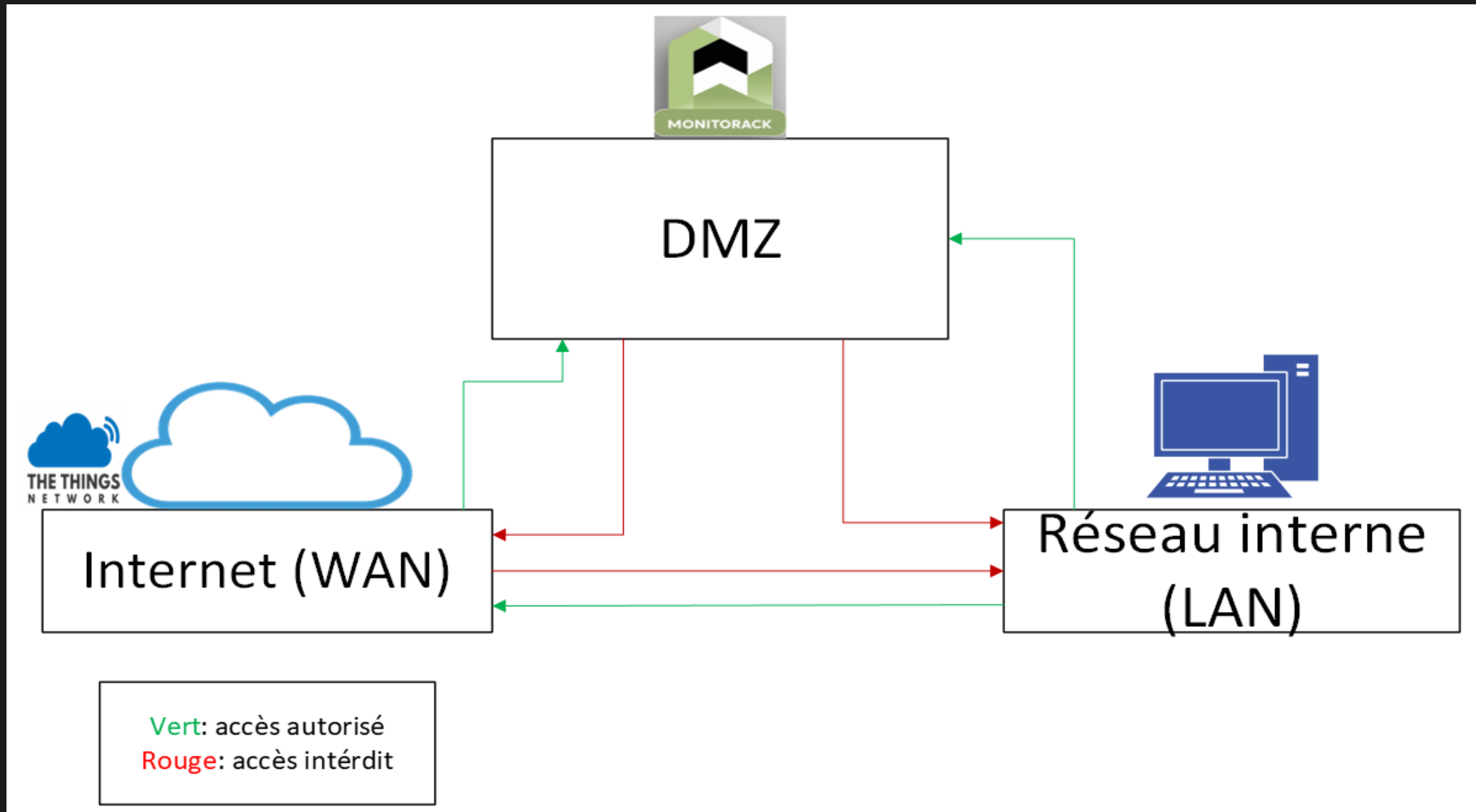

- **Un pare-feu**
 - **un outil de sécurité**
 - **contrôle le trafic réseau en **filtrant** les communications entre différentes parties du réseau selon des **règles** configurées**
-
- **Une zone démilitarisée**
 - **un sous-réseau isolé**
 - **Permet de rajouter une couche de sécurité entre un réseau interne et Internet**



LES RÈGLES D'UN PFSENSE ET D'UNE DMZ :



BILAN

- **Le rapport de projet** 
- **Firewall + DMZ** 
- **Communication avec LoRaWan** 
- **Routes** 
- **Méthodes ORM** 
- **Passer le site sur le port 443** 
- **Sauvegardes de la base de données** 

MERCI !

ANNEXE: ONDULEUR DOUBLE CONVERSION

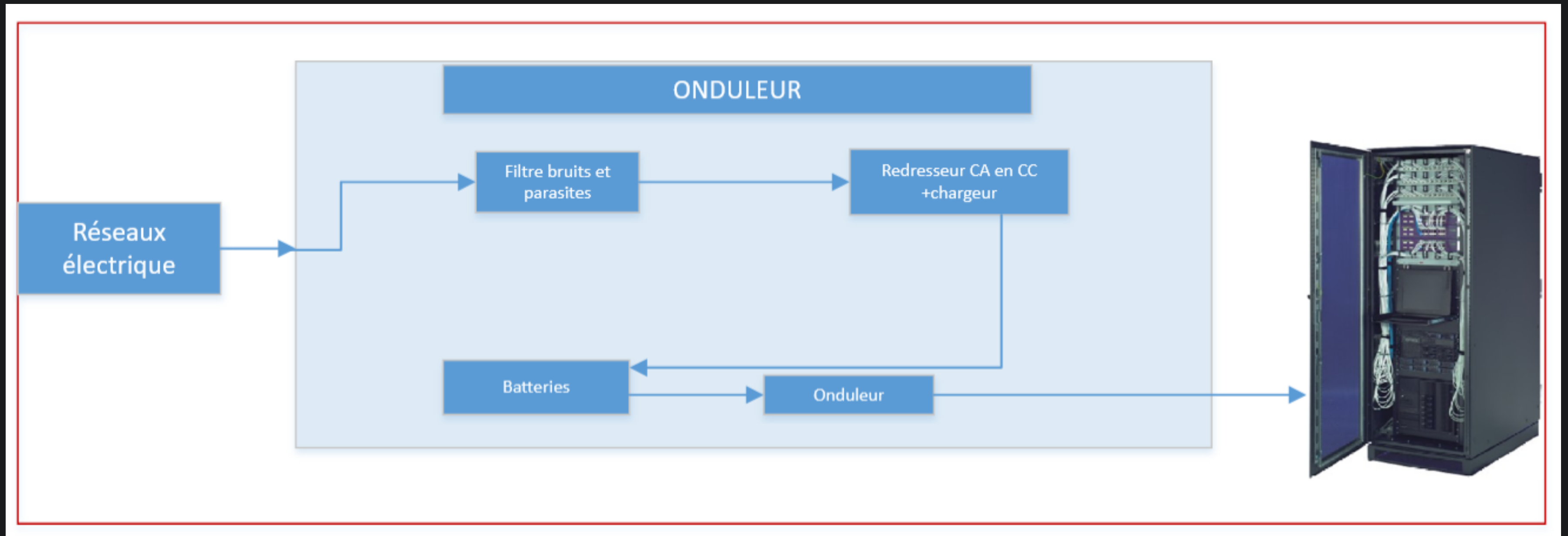

ANNEXE: ONDULEUR OFFLINE

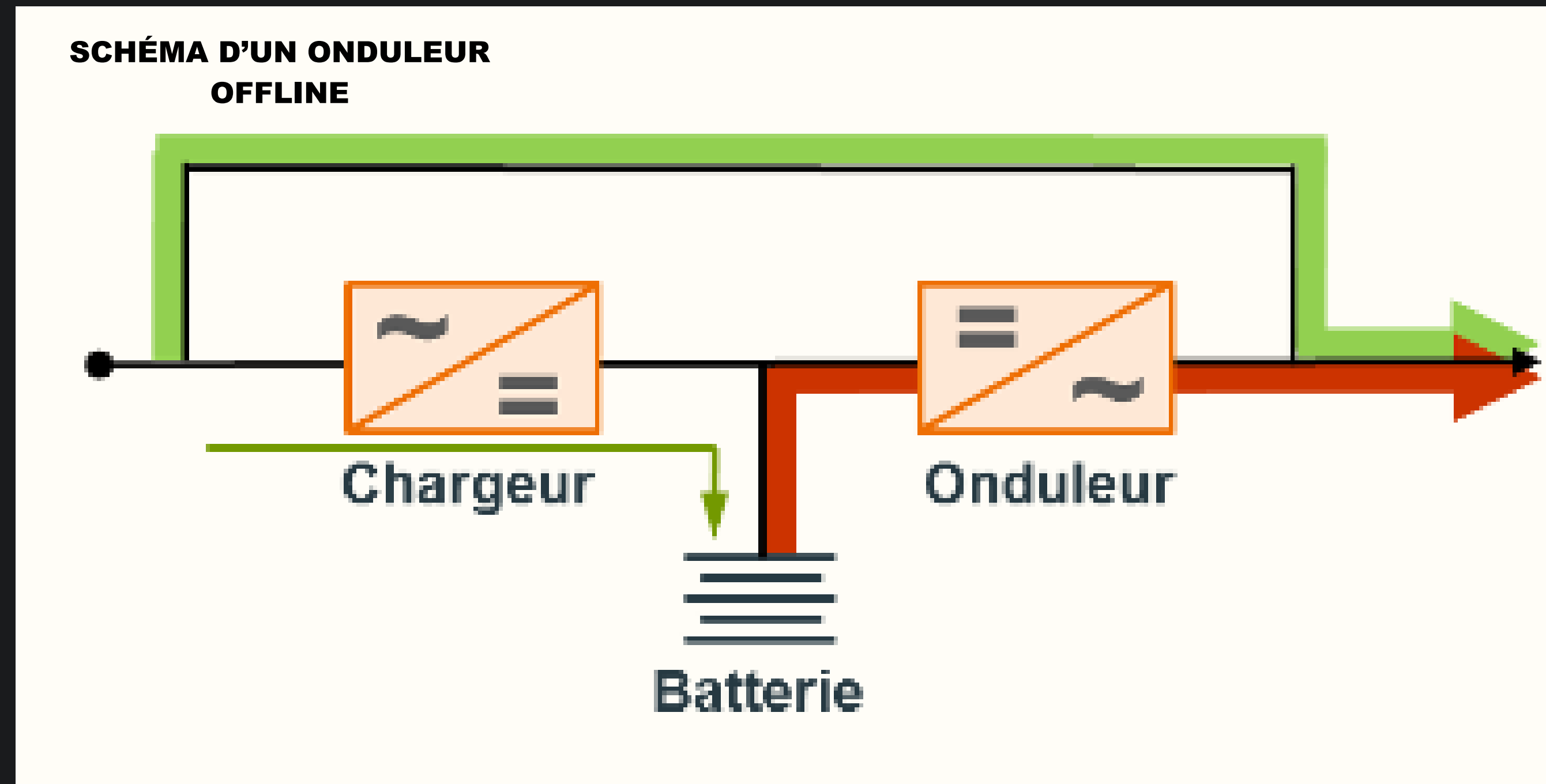

ANNEXE: SCHEMA INFRASTRUCTURE RÉSEAU

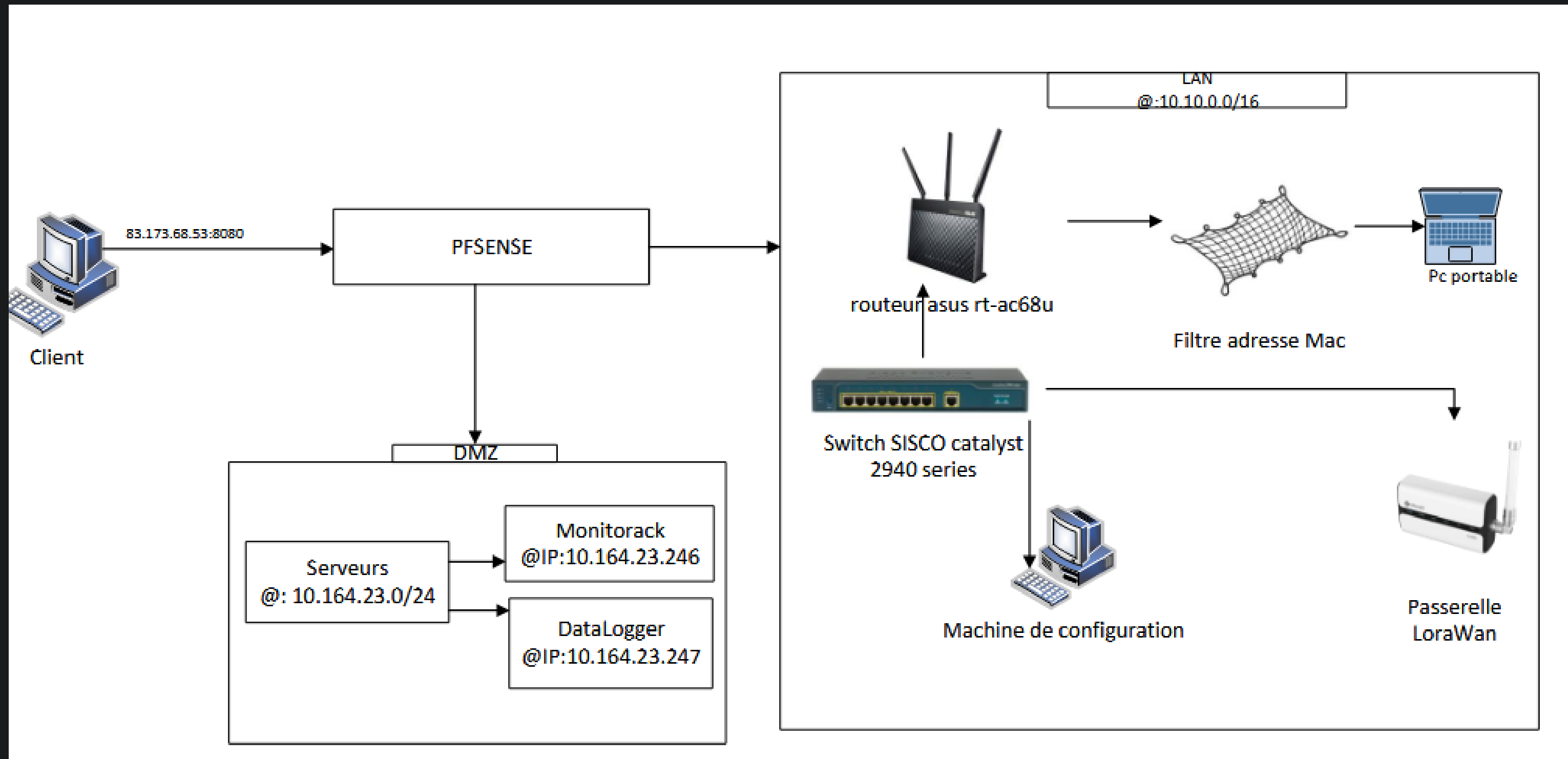

ANNEXE

<https://www.se.com/ch/fr/products-runtime-graph/SMT3000RMI2UC/onduleur-apc-smartups-3-000-va-%C3%A9cran-lcd-montage-en-rack-2u-230v-avec-smartconnect/>